

IRGIB10B60KD1

INSULATED GATE BIPOLAR TRANSISTOR WITH ULTRAFAST SOFT RECOVERY DIODE

Features

- Low VCE (on) Non Punch Through IGBT Technology.
- Low Diode VF.
- 10µs Short Circuit Capability.
- Square RBSOA.
- Ultrasoft Diode Reverse Recovery Characteristics.
- Positive VCE (on) Temperature Coefficient.
- Maximum Junction Temperature Rated at 175°C

Benefits

- Benchmark Efficiency for Motor Control.
- Rugged Transient Performance.
- Low EMI.
- Excellent Current Sharing in Parallel Operation.

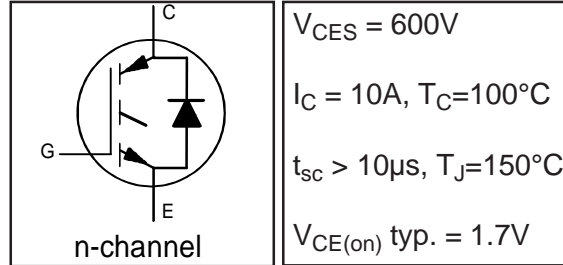

Absolute Maximum Ratings

	Parameter	Max.	Units
V_{CES}	Collector-to-Emitter Voltage	600	V
$I_C @ T_C = 25^\circ C$	Continuous Collector Current	16	A
$I_C @ T_C = 100^\circ C$	Continuous Collector Current	10	
I_{CM}	Pulse Collector Current (Ref.Fig.C.T.5)	32	
I_{LM}	Clamped Inductive Load current ①	32	
$I_F @ T_C = 25^\circ C$	Diode Continuous Forward Current	16	
$I_F @ T_C = 100^\circ C$	Diode Continuous Forward Current	10	V
I_{FM}	Diode Maximum Forward Current	32	
V_{ISOL}	RMS Isolation Voltage, Terminal to Case, $t = 1 \text{ min}$	2500	
V_{GE}	Gate-to-Emitter Voltage	± 20	W
$P_D @ T_C = 25^\circ C$	Maximum Power Dissipation	44	
$P_D @ T_C = 100^\circ C$	Maximum Power Dissipation	22	$^\circ C$
T_J	Operating Junction and	-55 to +175	
T_{STG}	Storage Temperature Range		
	Soldering Temperature for 10 sec.	300 (0.063 in. (1.6mm) from case)	
	Mounting Torque, 6-32 or M3 Screw	10 lbf.in (1.1N.m)	

Thermal / Mechanical Characteristics

	Parameter	Min.	Typ.	Max.	Units
$R_{\theta JC}$	Junction-to-Case- IGBT	—	—	3.4	$^\circ C/W$
$R_{\theta JC}$	Junction-to-Case- Diode	—	—	5.3	
$R_{\theta CS}$	Case-to-Sink, flat, greased surface	—	0.50	—	
$R_{\theta JA}$	Junction-to-Ambient, typical socket mount	—	—	62	
Wt	Weight	—	2.0	—	g

IRGIB10B60KD1

Electrical Characteristics @ T_J = 25°C (unless otherwise specified)

International
IR Rectifier

	Parameter	Min.	Typ.	Max.	Units	Conditions
V _{(BR)CES}	Collector-to-Emitter Breakdown Voltage	600	—	—	V	V _{GE} = 0V, I _C = 500μA
ΔV _{(BR)CES} /ΔT _J	Temperature Coeff. of Breakdown Voltage	—	0.99	—	V/°C	V _{GE} = 0V, I _C = 1mA (25°C-150°C)
V _{CE(on)}	Collector-to-Emitter Voltage	1.50	1.70	2.10	V	I _C = 10A, V _{GE} = 15V, T _J = 25°C
		—	2.05	2.35		I _C = 10A, V _{GE} = 15V, T _J = 150°C
		—	2.06	2.35		I _C = 10A, V _{GE} = 15V, T _J = 175°C
V _{GE(th)}	Gate Threshold Voltage	3.5	4.5	5.5	V	V _{CE} = V _{GE} , I _C = 250μA
ΔV _{GE(th)} /ΔT _J	Threshold Voltage temp. coefficient	—	-10	—	mV/°C	V _{CE} = V _{GE} , I _C = 1mA (25°C-150°C)
g _{fe}	Forward Transconductance	—	5.0	—	S	V _{CE} = 50V, I _C = 10A, PW = 80μs
I _{CES}	Zero Gate Voltage Collector Current	—	1.0	150	μA	V _{GE} = 0V, V _{CE} = 600V
		—	90	250		V _{GE} = 0V, V _{CE} = 600V, T _J = 150°C
		—	150	400		V _{GE} = 0V, V _{CE} = 600V, T _J = 175°C
V _{FM}	Diode Forward Voltage Drop	—	1.80	2.40	V	I _F = 5.0A, V _{GE} = 0V
		—	1.32	1.74		I _F = 5.0A, V _{GE} = 0V, T _J = 150°C
		—	1.23	1.62		I _F = 5.0A, V _{GE} = 0V, T _J = 175°C
I _{GES}	Gate-to-Emitter Leakage Current	—	—	±100	nA	V _{GE} = ±20V, V _{CE} = 0V

Switching Characteristics @ T_J = 25°C (unless otherwise specified)

	Parameter	Min.	Typ.	Max.	Units	Conditions
Q _g	Total Gate Charge (turn-on)	—	41	62	nC	I _C = 10A V _{CC} = 400V V _{GE} = 15V
Q _{ge}	Gate-to-Emitter Charge (turn-on)	—	4.6	6.9		
Q _{gc}	Gate-to-Collector Charge (turn-on)	—	19	29		
E _{on}	Turn-On Switching Loss	—	156	264	μJ	I _C = 10A, V _{CC} = 400V V _{GE} = 15V, R _G = 50Ω, L = 1.07mH L _S = 150nH, T _J = 25°C ⊙
E _{off}	Turn-Off Switching Loss	—	165	273		
E _{tot}	Total Switching Loss	—	321	434		
t _{d(on)}	Turn-On delay time	—	25	33	ns	I _C = 10A, V _{CC} = 400V V _{GE} = 15V, R _G = 50Ω, L = 1.1mH L _S = 150nH, T _J = 25°C
t _r	Rise time	—	24	34		
t _{d(off)}	Turn-Off delay time	—	180	250		
t _f	Fall time	—	62	87		
E _{on}	Turn-On Switching Loss	—	261	372	μJ	I _C = 10A, V _{CC} = 400V V _{GE} = 15V, R _G = 50Ω, L = 1.07mH L _S = 150nH, T _J = 150°C ⊙
E _{off}	Turn-Off Switching Loss	—	313	425		
E _{tot}	Total Switching Loss	—	574	694		
t _{d(on)}	Turn-On delay time	—	22	31		
t _r	Rise time	—	24	34	ns	I _C = 8.0A, V _{CC} = 400V V _{GE} = 15V, R _G = 50Ω, L = 1.07mH L _S = 150nH, T _J = 150°C
t _{d(off)}	Turn-Off delay time	—	240	340		
t _f	Fall time	—	48	67		
L _E	Internal Emitter Inductance	—	7.5	—		nH
C _{ies}	Input Capacitance	—	610	915	pF	V _{GE} = 0V V _{CC} = 30V f = 1.0MHz
C _{oes}	Output Capacitance	—	66	99		
C _{res}	Reverse Transfer Capacitance	—	23	35		
RBSOA	Reverse Bias Safe Operating Area	FULL SQUARE				T _J = 150°C, I _C = 32A, V _p = 600V V _{CC} = 500V, V _{GE} = +15V to 0V, R _G = 50Ω
SCSOA	Short Circuit Safe Operating Area	10	—	—	μs	T _J = 150°C, V _p = 600V, R _G = 50Ω V _{CC} = 360V, V _{GE} = +15V to 0V
I _{SC (PEAK)}	Peak Short Circuit Collector Current	—	100	—	A	
E _{rec}	Reverse Recovery Energy of the Diode	—	99	128	μJ	T _J = 150°C
t _{rr}	Diode Reverse Recovery Time	—	79	103	ns	V _{CC} = 400V, I _F = 10A, L = 1.07mH
I _{rr}	Peak Reverse Recovery Current	—	14	18	A	V _{GE} = 15V, R _G = 50Ω
Q _{rr}	Diode Reverse Recovery Charge	—	553	719	nC	di/dt = 500A/μs

⊙ V_{CC} = 80% (V_{CES}), V_{GE} = 20V, L = 100μH, R_G = 50Ω.

⊙ Energy losses include "tail" and diode reverse recovery.

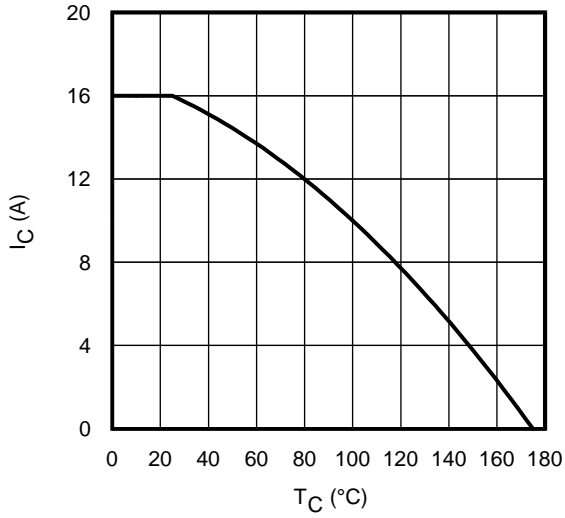

Fig. 1 - Maximum DC Collector Current vs. Case Temperature

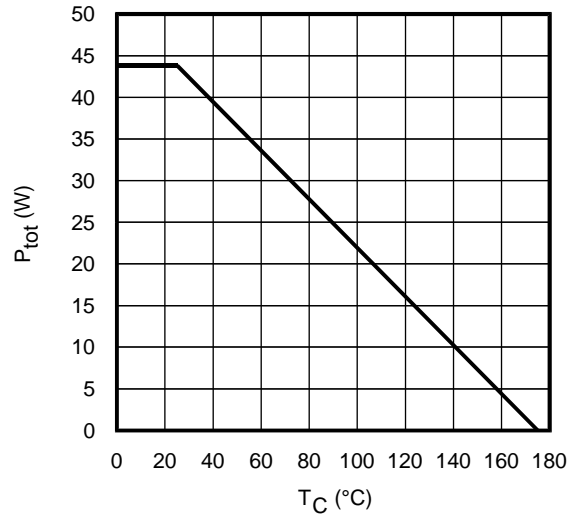

Fig. 2 - Power Dissipation vs. Case Temperature

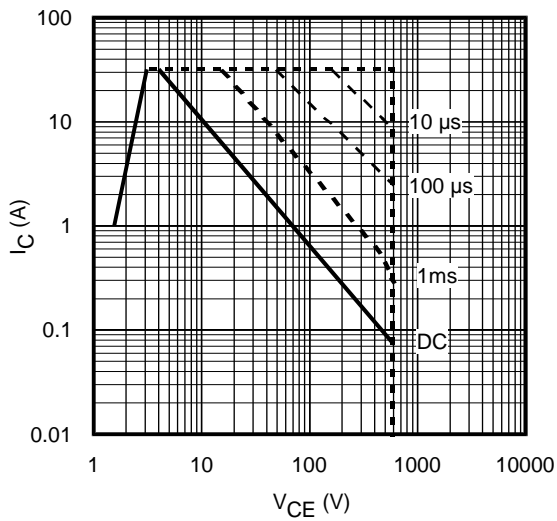

Fig. 3 - Forward SOA
 $T_C = 25^\circ\text{C}$; $T_J \leq 175^\circ\text{C}$

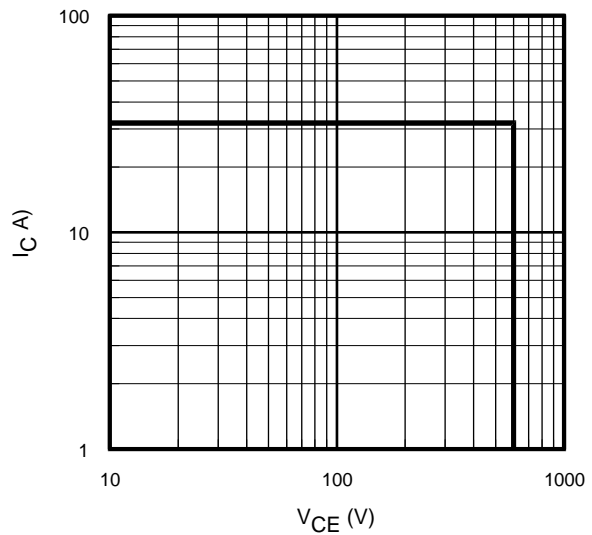

Fig. 4 - Reverse Bias SOA
 $T_J = 150^\circ\text{C}$; $V_{GE} = 15\text{V}$

IRGIB10B60KD1

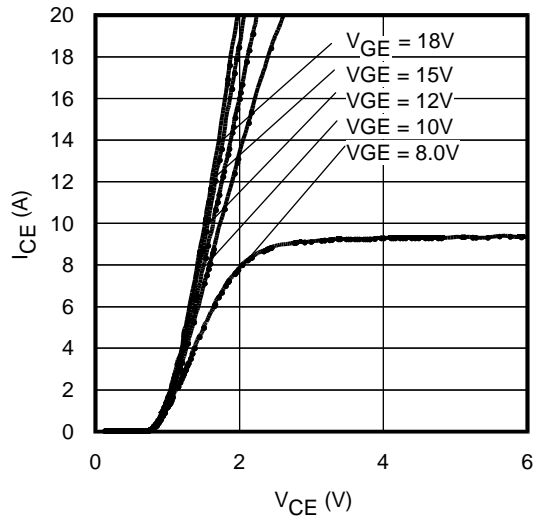

Fig. 5 - Typ. IGBT Output Characteristics
 $T_J = -40^\circ\text{C}$; $t_p = 80\mu\text{s}$

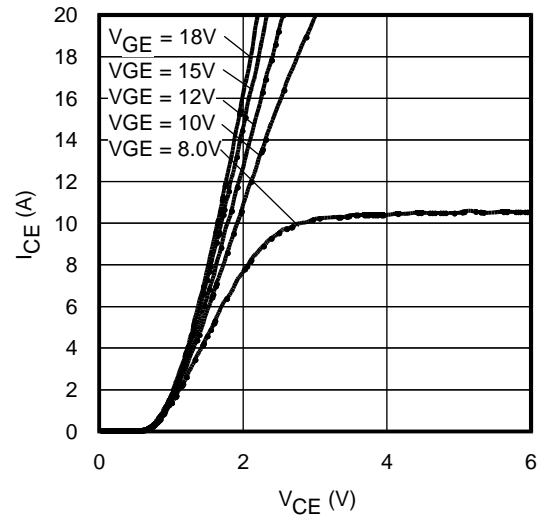

Fig. 6 - Typ. IGBT Output Characteristics
 $T_J = 25^\circ\text{C}$; $t_p = 80\mu\text{s}$

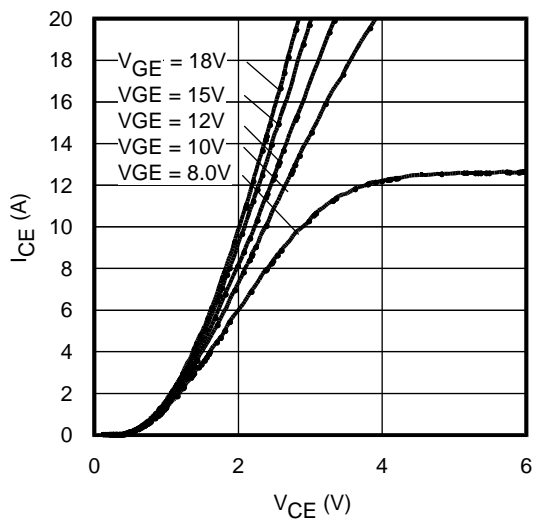

Fig. 7 - Typ. IGBT Output Characteristics
 $T_J = 150^\circ\text{C}$; $t_p = 80\mu\text{s}$

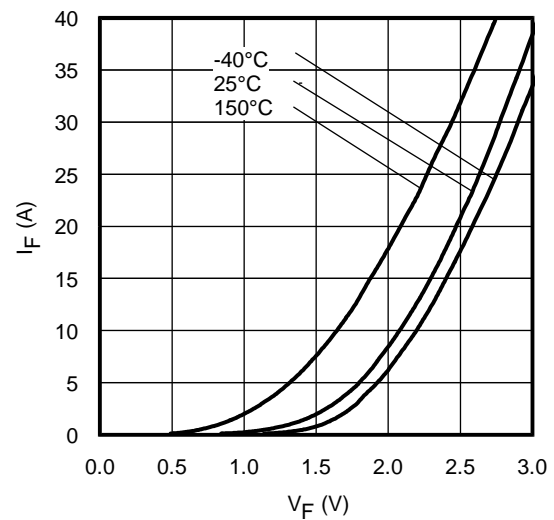

Fig. 8 - Typ. Diode Forward Characteristics
 $t_p = 80\mu\text{s}$

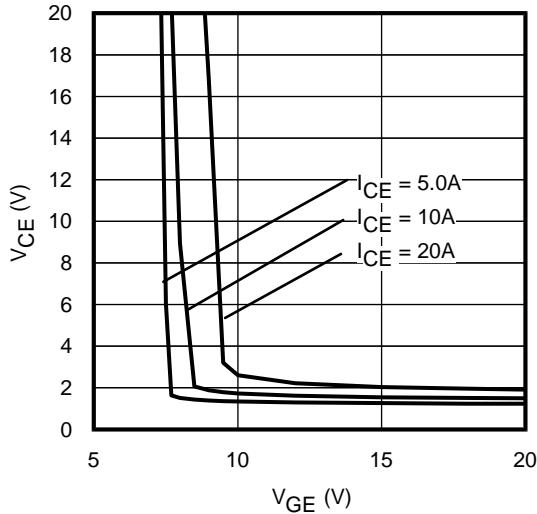

Fig. 9 - Typical V_{CE} vs. V_{GE}
 $T_J = -40^\circ\text{C}$

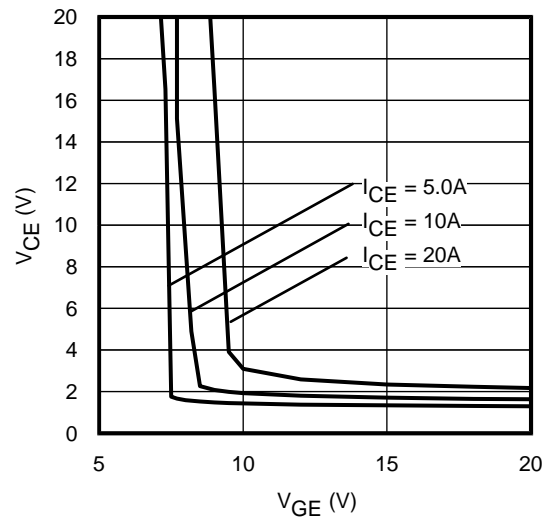

Fig. 10 - Typical V_{CE} vs. V_{GE}
 $T_J = 25^\circ\text{C}$

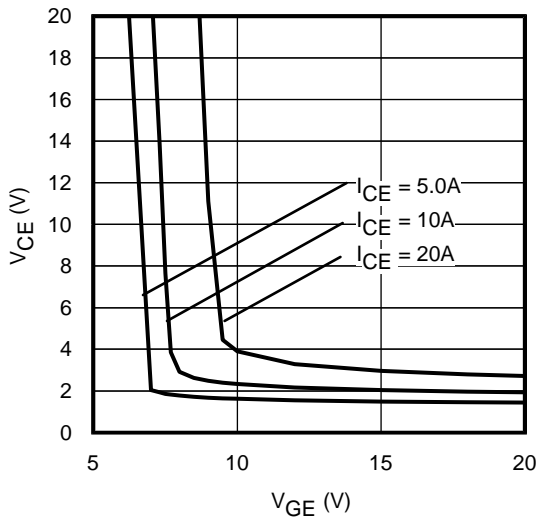

Fig. 11 - Typical V_{CE} vs. V_{GE}
 $T_J = 150^\circ\text{C}$

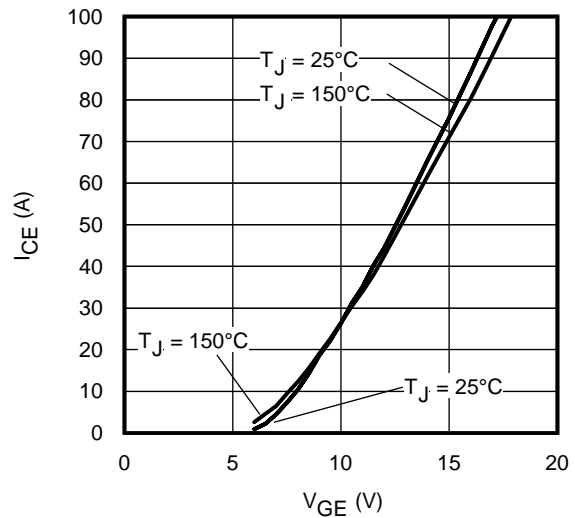

Fig. 12 - Typ. Transfer Characteristics
 $V_{CE} = 50\text{V}$; $t_p = 10\mu\text{s}$

IRGIB10B60KD1

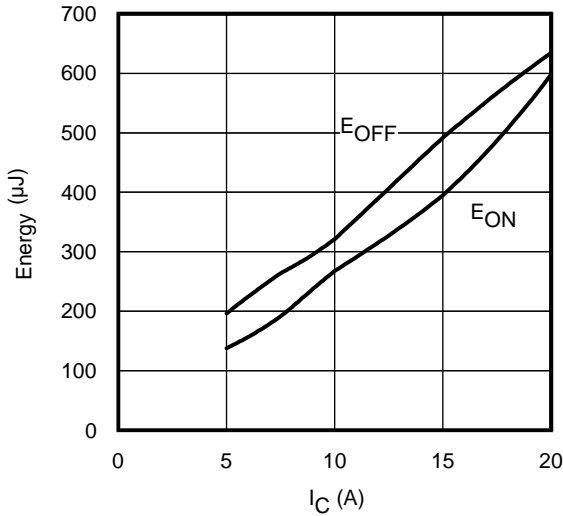

Fig. 13 - Typ. Energy Loss vs. I_C
 $T_J = 150^\circ\text{C}$; $L = 1.07\text{mH}$; $V_{CE} = 400\text{V}$
 $R_G = 50\Omega$; $V_{GE} = 15\text{V}$

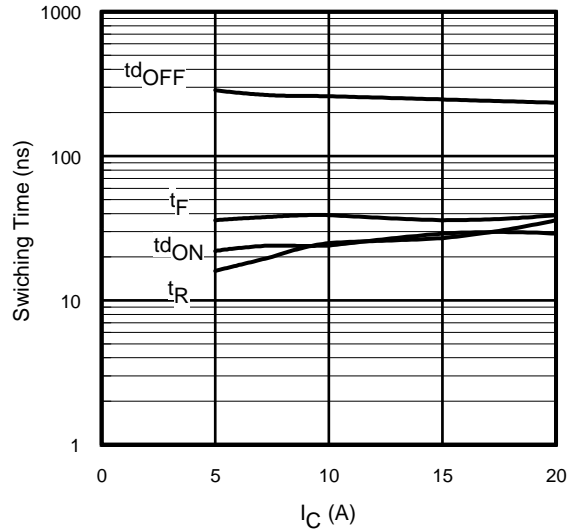

Fig. 14 - Typ. Switching Time vs. I_C
 $T_J = 150^\circ\text{C}$; $L = 1.07\text{mH}$; $V_{CE} = 400\text{V}$
 $R_G = 50\Omega$; $V_{GE} = 15\text{V}$

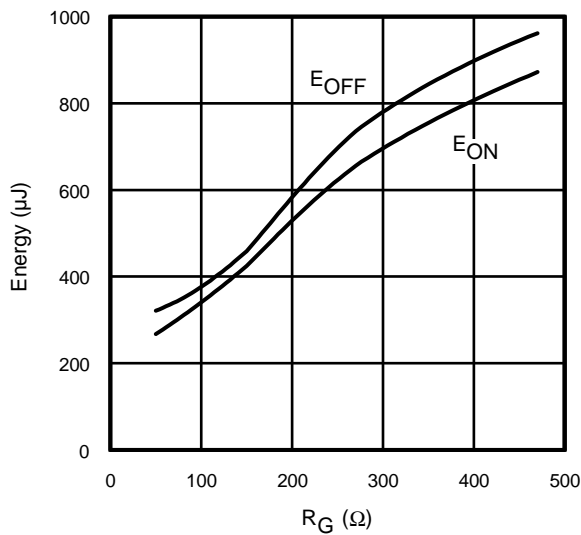

Fig. 15 - Typ. Energy Loss vs. R_G
 $T_J = 150^\circ\text{C}$; $L = 1.07\text{mH}$; $V_{CE} = 400\text{V}$
 $I_{CE} = 10\text{A}$; $V_{GE} = 15\text{V}$

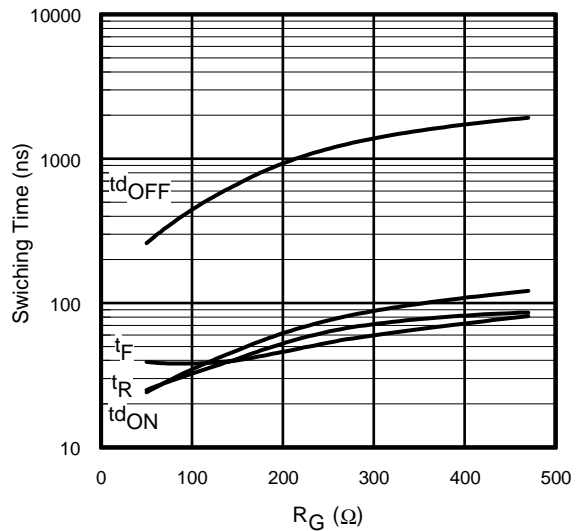

Fig. 16 - Typ. Switching Time vs. R_G
 $T_J = 150^\circ\text{C}$; $L = 1.07\text{mH}$; $V_{CE} = 400\text{V}$
 $I_{CE} = 10\text{A}$; $V_{GE} = 15\text{V}$

IRGIB10B60KD1

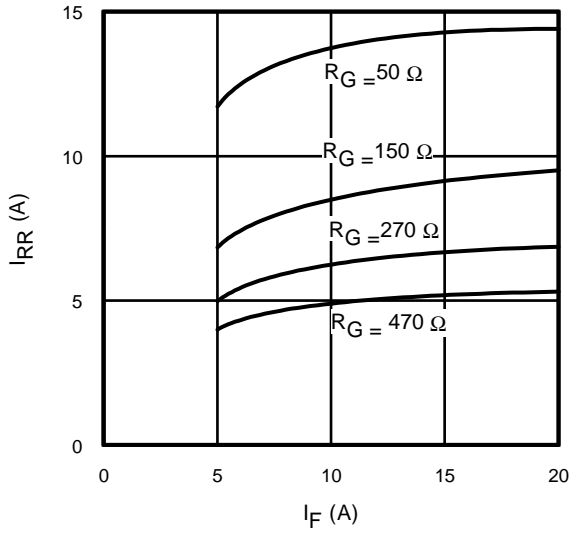

Fig. 17 - Typical Diode I_{RR} vs. I_F
 $T_J = 150^\circ\text{C}$

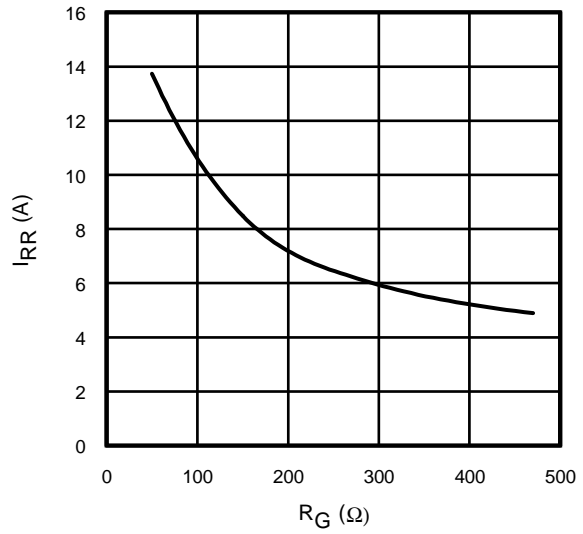

Fig. 18 - Typical Diode I_{RR} vs. R_G
 $T_J = 150^\circ\text{C}$; $I_F = 10\text{A}$

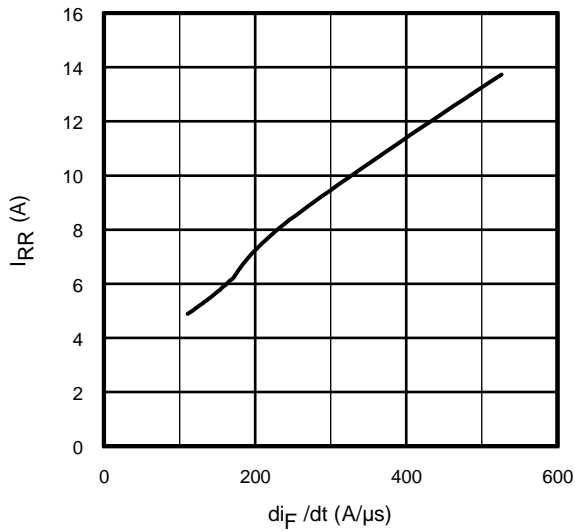

Fig. 19- Typical Diode I_{RR} vs. di_F/dt
 $V_{CC} = 400\text{V}$; $V_{GE} = 15\text{V}$;
 $I_{CE} = 10\text{A}$; $T_J = 150^\circ\text{C}$

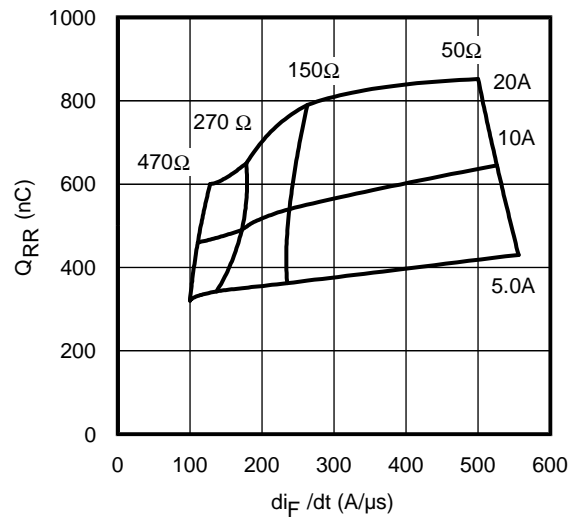

Fig. 20 - Typical Diode Q_{RR}
 $V_{CC} = 400\text{V}$; $V_{GE} = 15\text{V}$; $T_J = 150^\circ\text{C}$

IRGIB10B60KD1

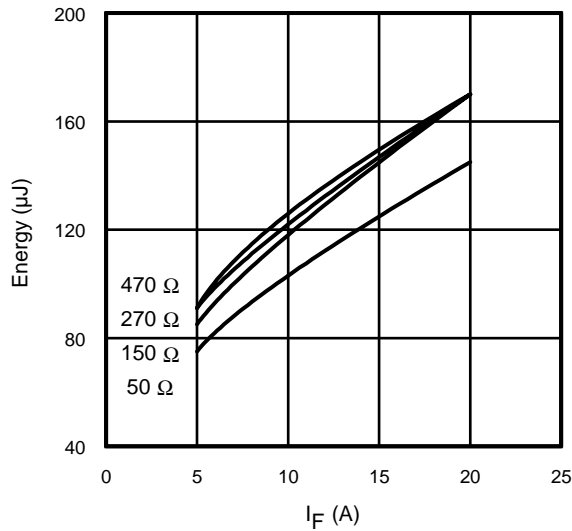

Fig. 21 - Typical Diode E_{RR} vs. I_F
 $T_J = 150^\circ\text{C}$

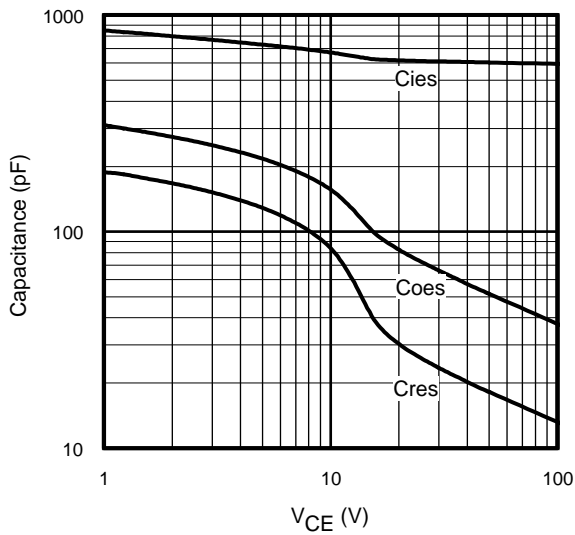

Fig. 22- Typ. Capacitance vs. V_{CE}
 $V_{GE} = 0\text{V}$; $f = 1\text{MHz}$

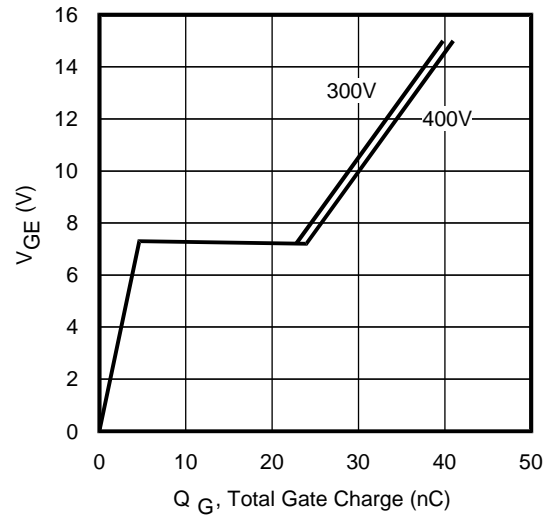

Fig. 23 - Typical Gate Charge vs. V_{GE}
 $I_{CE} = 10\text{A}$; $L = 2500\mu\text{H}$

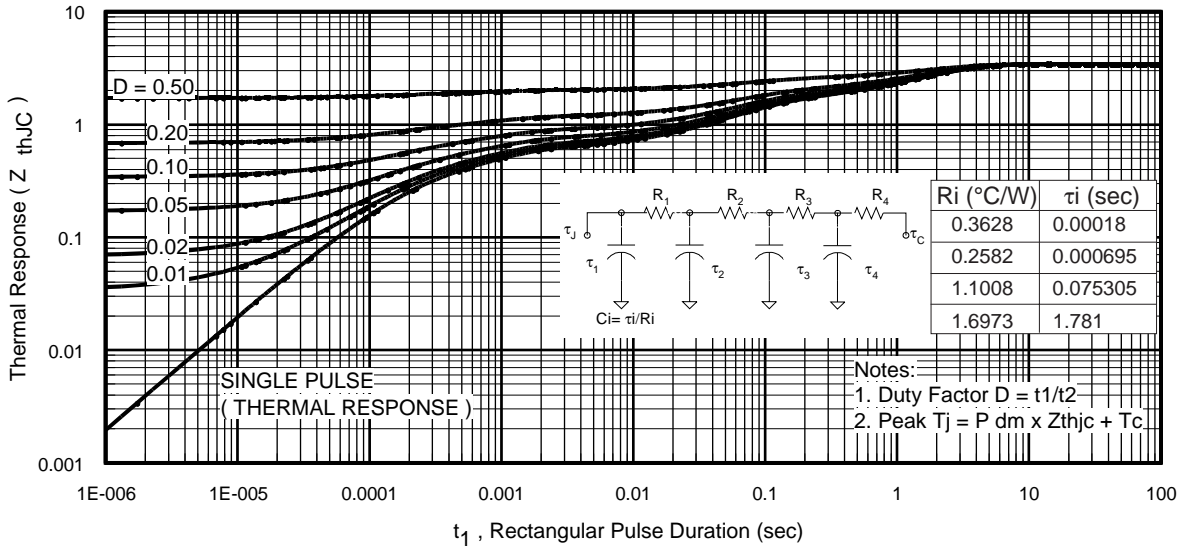

Fig 24. Maximum Transient Thermal Impedance, Junction-to-Case (IGBT)

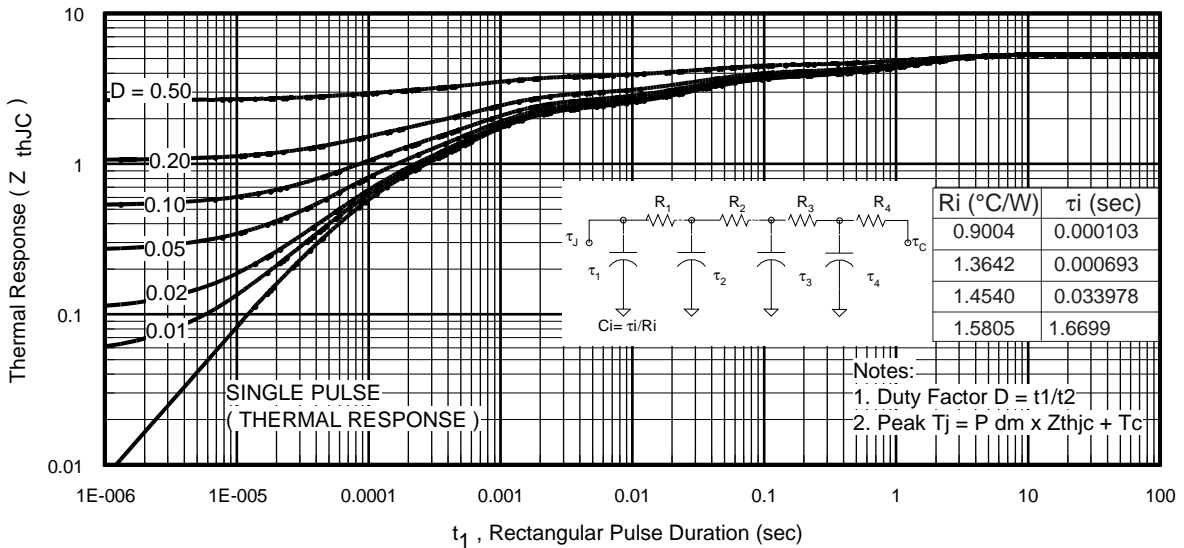

Fig 25. Maximum Transient Thermal Impedance, Junction-to-Case (DIODE)

IRGIB10B60KD1

International
IR Rectifier

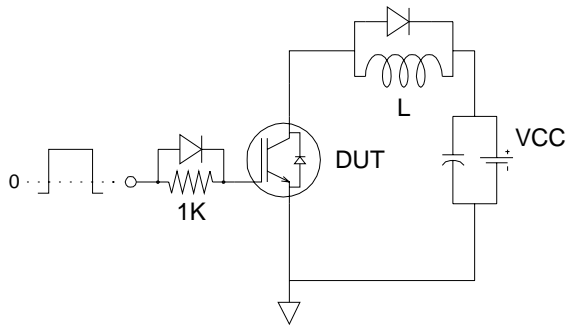

Fig.C.T.1 - Gate Charge Circuit (turn-off)

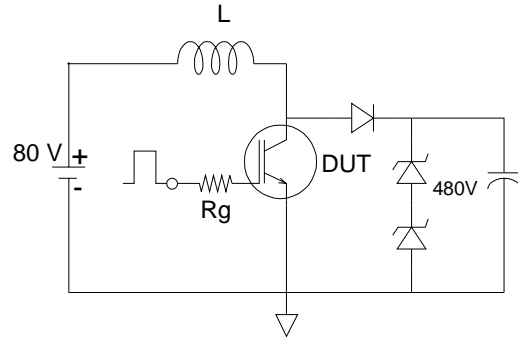

Fig.C.T.2 - RBSOA Circuit

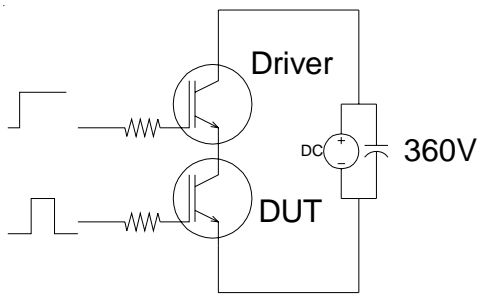

Fig.C.T.3 - S.C.SOA Circuit

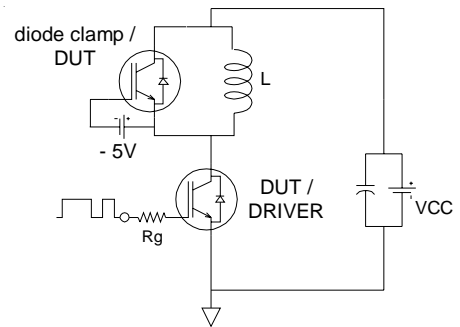

Fig.C.T.4 - Switching Loss Circuit

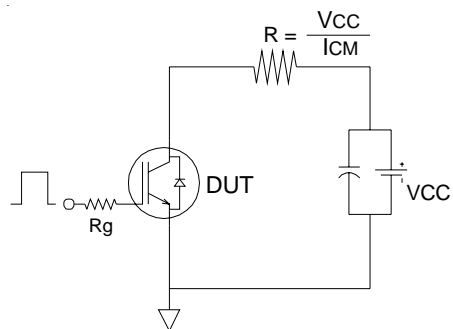

Fig.C.T.5 - Resistive Load Circuit

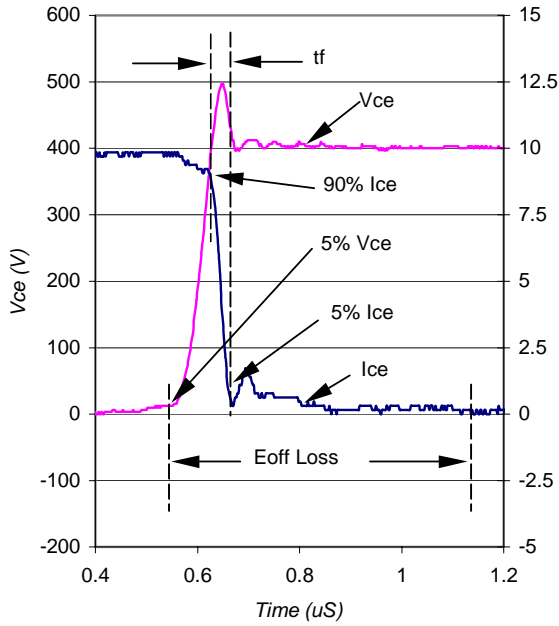

Fig. WF1- Typ. Turn-off Loss Waveform
@ $T_J = 150^\circ\text{C}$ using Fig. CT.4

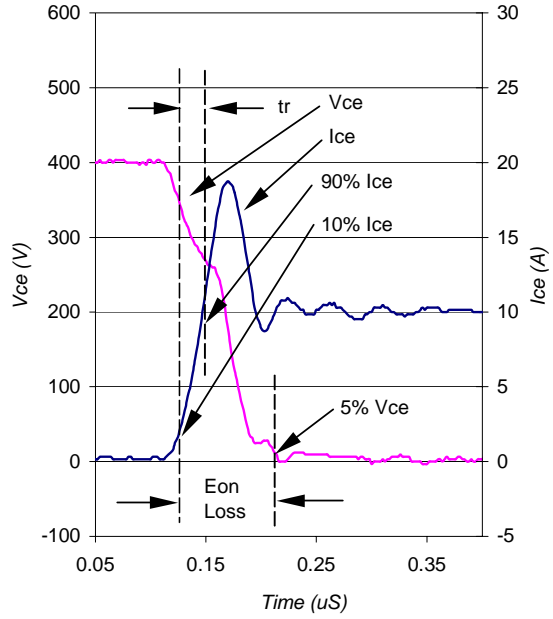

Fig. WF2- Typ. Turn-on Loss Waveform
@ $T_J = 150^\circ\text{C}$ using Fig. CT.4

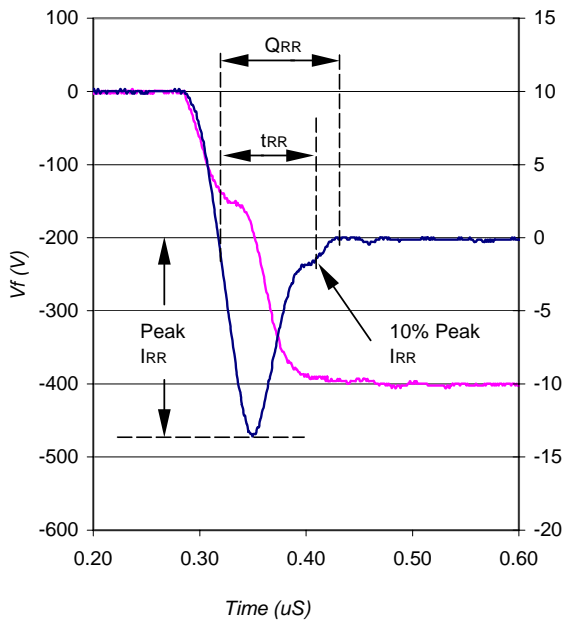

Fig. WF3- Typ. Diode Recovery Waveform
@ $T_J = 150^\circ\text{C}$ using Fig. CT.4

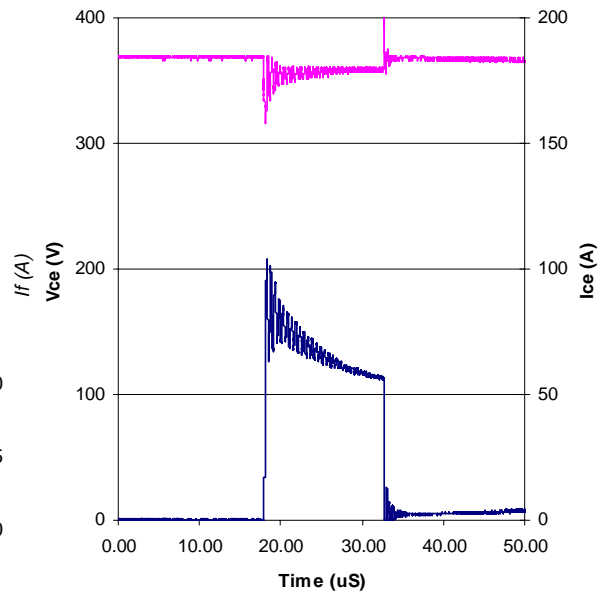

Fig. WF4- Typ. S.C Waveform
@ $T_C = 150^\circ\text{C}$ using Fig. CT.3

IRGIB10B60KD1



TO-220 Full-Pak Package Outline

Dimensions are shown in millimeters (inches)

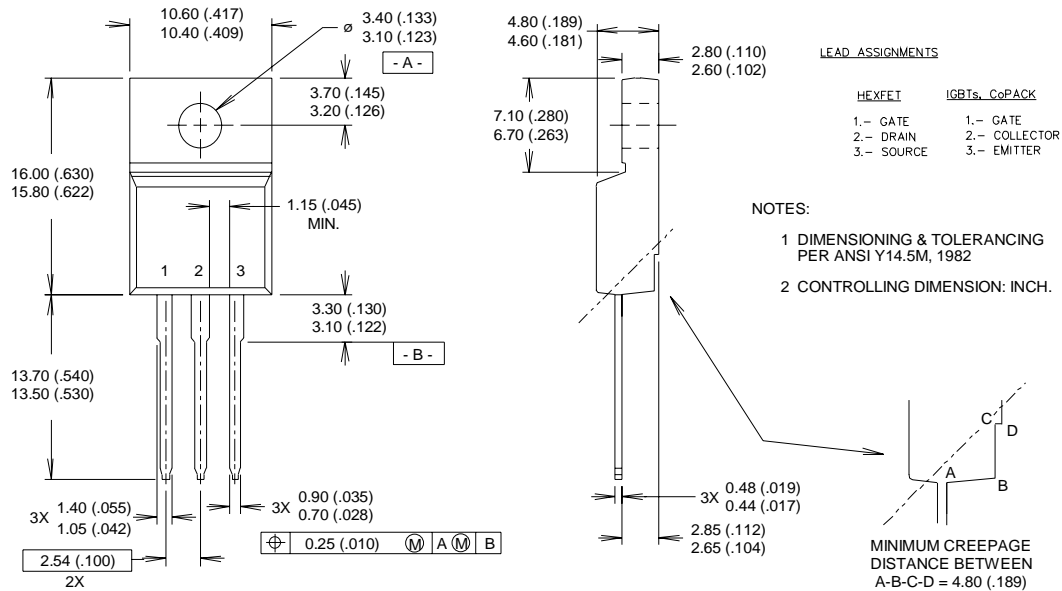

TO-220 Full-Pak Part Marking Information

EXAMPLE: THIS IS AN IRF1840G
WITH ASSEMBLY
LOT CODE 3432
ASSEMBLED ON WW 24 1999
IN THE ASSEMBLY LINE "K"

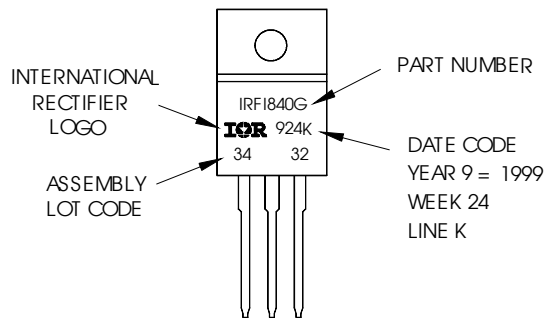

TO-220 Full-Pak package is not recommended for Surface Mount Application

Data and specifications subject to change without notice.

This product has been designed and qualified for the Industrial market.

Qualification Standards can be found on IR's Web site.



IR WORLD HEADQUARTERS: 233 Kansas St., El Segundo, California 90245, USA Tel: (310) 252-7105
TAC Fax: (310) 252-7903

Visit us at www.irf.com for sales contact information.2/04